

Installation Instruction

Rosenberger

Rosenberger cold weld connector for 1/2" annular corrugated coax. cable

MA_1P1-C03



Cold Weld toolset:
Rosenberger 11W119-C03/90 inserts with RIDGID tool RP 210/240 and Press Frameset 7/8"



A) SLZ0002-000



B) 60W018-C03



SLZ0009-000
SLZ0009-001
SLZ0009-003



SLT010-C03



SLWK111P-C03 (optional)



Stripping toolset:
Rosenberger 60W018-C03 with drill or handle configuration

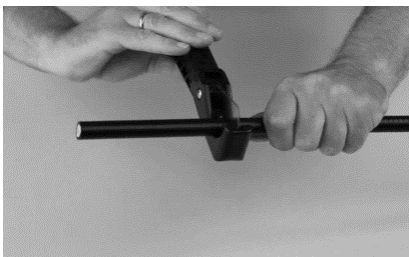

- 1) Straighten the first 250mm (10") of the cable.
- 2) Cut the first 40 mm (1.5") of the cable with cable cutter shown on picture A)



- 3) Insert the boot on the cable (optional)
- 4) Clean cable with a cloth to remove any grease that may have deposited on it.

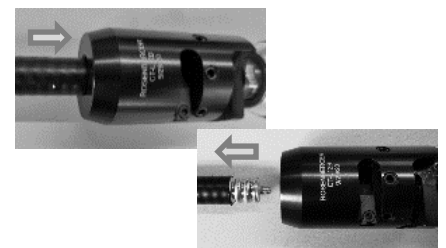

- 5) Insert the cable into the stripping tool
- 6) Strip cable with the drill set on low speed to remove the jacket, the outer conductor, and the insulator. The tool will chamfer the center conductor
- 7) Pull cable out of stripping tool
- 8) **Important: Check the outer conductor, it has to be cut in middle of crest because of the electrical performance!**

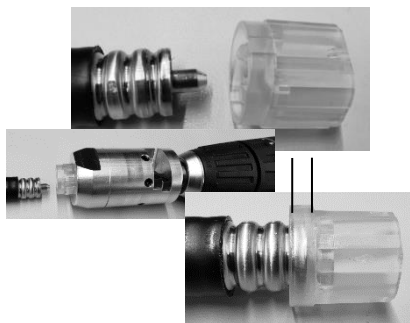
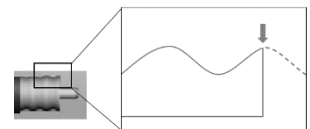

- 9) Remove the dielectric from center conductor with SLT010-C03 and with the drill set on high speed and then make sure to clean any shavings left by the prep tool
- 10) Check removed dielectric by observing the depth from the edge of the outer conductor to the underneath of the corrugation dale

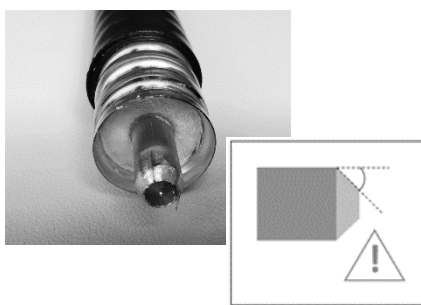

- 11) All surfaces incl. the jacket, the inner and outer conductors have to be clean without any shavings or residues.
The chamfer on the inner conductor is very important for future assembling.
- 12) Check the roundness of the outer conductor.

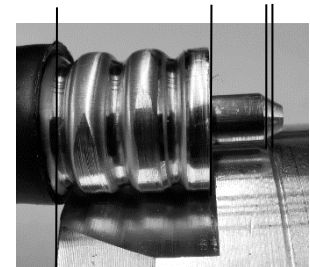

- 13) Check the stripping dimensions with the gauge included on tool.

vertraulich | confidential

Installation Instruction

Rosenberger

Rosenberger cold weld connector for 1/2" annular corrugated coax. cable

MA_1P1-C03

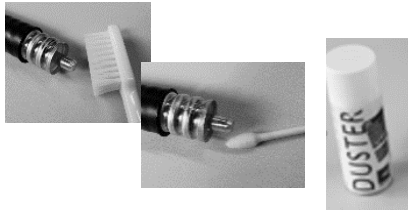

14) Clean the cut surfaces of the inner conductor, the dielectric and the outer conductor with brush, alcohol and the compressed air

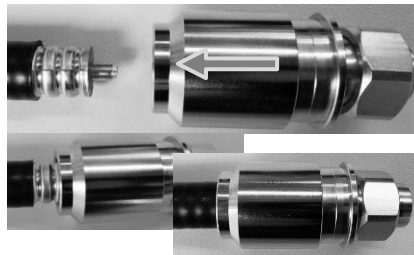

15) Insert the prepped end of the cable into the back of the connector until the outer conductor snaps into place right after the first resistance.

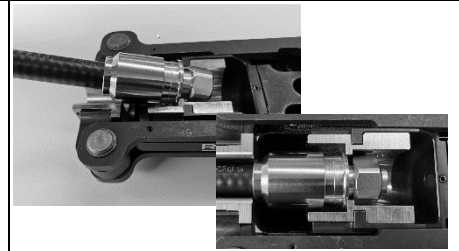

16) Place the connector with cable into the frame set with the proper inserts previously inserted in the tool and make sure connector is fully flat seated in frame.

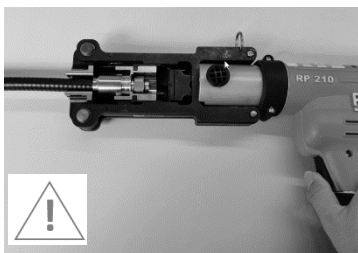

17) Press tool trigger until gun cycles. Do not pull or push on tool during compression.
18) Keep hands off the frameset while the tool is running. Refer to the RIDGID tool manual for a safe operation.

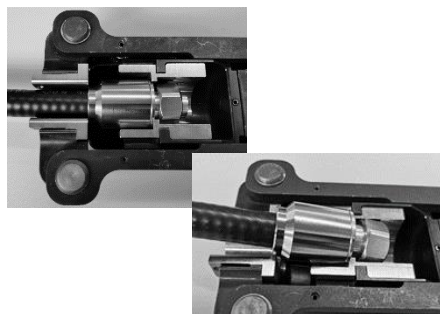

19) Make sure the connector has been fully compressed until stop.
20) Carefully take the compressed connector and cable out of the frameset



21) The Cold Weld connector install is complete.
22) Check the stripping tool for any cable debris. Clean accordingly. Keeping this tool clean after every operation will help extending the operational life.



23) If a boot was required and placed in step 3 (optional), push the boot closer to the assembled connector to prepare for the the sealing on the mated connector pair.



24) Boot install is complete after the connector is mated.

* In harsh and aggressive environments, e.g. coastal areas, areas with high ammonia concentration etc., the weather proofing boot SLWK111P-C03 is recommended for material protection.

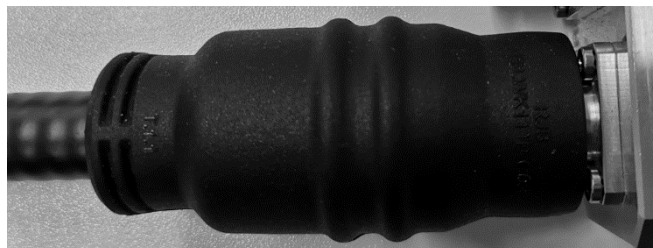

- Link of assembly instruction: https://www.rosenberger.com/isis/cold-weld-instruction/ma_1p1-c03
- Link of video: <https://www.rosenberger.com/coldweld>

Safety requirements:

Protect yourself with safety glasses, safety shoes and gloves.

While the information has been carefully compiled to the best of our knowledge, nothing is intended as representation or warranty on our part and no statement herein shall be construed as recommendation to infringe existing patents. In the effort to improve our products, we reserve the right to make changes judged to be necessary.

For the installation of the electrotechnical equipment, particular electrotechnical expertise is required.



Draft	Date	Approved	Date	Rev.	Engineering change number	Name	Date
Rong Fang	16.01.2020	Martin Wimmer	20.01.2022	300	22-0009	Rong Fang	20.01.2022

Rosenberger Hochfrequenztechnik GmbH & Co. KG
P.O.Box 1260 D-84526 Tittmoning Germany
www.rosenberger.de

Tel. : +49 8684 18-0
Email : info@rosenberger.de

Page
2 / 2